

TECHNICAL SPECIFICATIONS

CATEGORY: PULLBARS

MODEL: THE CENTER / 156 mm

TECHNICAL DRAWINGS (units in mm)

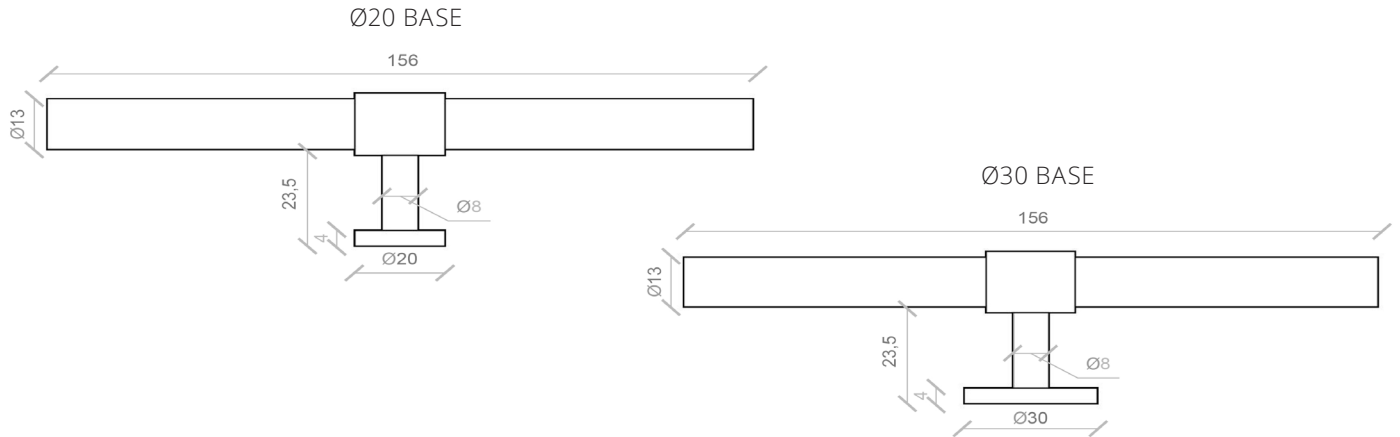

ALSO INCLUDED

1 x M4 x 25mm screw
(fits doors and drawers
of max 20mm*)

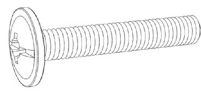

Please note that the
handle is fitted from
behind cabinet door and
can not be front face fitted.

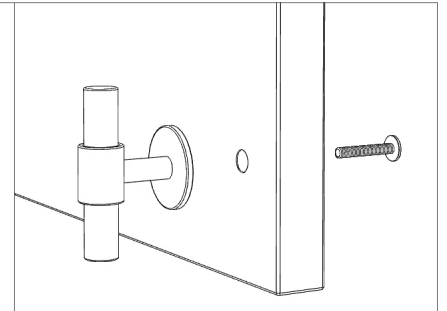

* For thicker doors/fronts you will need to source
longer M4 screws.

BEARING MATERIALS



1 2 3 4 5 6

1. Anthracite (ANT) 2. Burnished Brass (BB) 3. Polished Brass (PB) 4. Satin Brass (SB) 5. Polished Nickel (PN) 6. Satin Nickel (SN)

HANDLEBAR MATERIALS Ø13 mm



1 2 3 4 5 6 7 8 9 10

1. Anthracite (ANT) 2. Burnished Brass (BB) 3. Polished Brass (PB) 4. Satin Brass (SB) 5. Polished Nickel (PN) 6. Satin Nickel (SN)
7. Teak (TE) 8. Oak (OA) 9. Wenge (WE) 10. Black Horn (BH)

PRODUCT CARE

Our products are handmade and from natural materials thus variations may occur. It is part of the uniqueness of BRANDT COLLECTIVE's products. Aging is a part of the natural process, therefore please handle and maintain your product with care. Wipe with a damp cloth and do not use any chemicals.